

Touch Art Remote 7 Zone

Bluetooth Switch

(T13 107 B)

Technical Manual



Description:

Toyama Touch Art Blue switches are intelligent control devices that provides convenient and comfort to the user. Usage of SMD components not only ensures reliability but also makes the product highly compact for its functionality and features. The use of SMPS (Switch Mode Power supply) makes the Touch Art switches operational across countries from North America having 127V supply to European/Asian countries having 230Vsupply without any field setting. The switch will withstand a voltage of 440V for 3 minutes.The various functions can be performed from the wall unit or hand held IR remote. These switches will operate directly with TouchArt Blue Mobile App without any HUB/Gate or LAN.

Technical Data:

- Power Source : 90-270V/AC
- Power Frequency : 50-60Hz
- Number of Switching Zones : 7
- Load per switching zone : GLS bulbs 1000W
Halogen lamps 200W
LED fitting/Strip - 12V/3A to 5A driver – one number only
LED fitting /Strip - 12V/1A to 2A driver - two numbers only
- Remote Operating range : 25 Feet
- Operating Temperature : -10 to +55 °C
- Standby power Consumption : <10mW
- Bluetooth RF Transceiver : BLE 4.0
- Bluetooth Range : 25feet Open
- Android version : 4.4.4 and above

TOYAMA CONTROLS & SYSTEM PVT LTD

36A, KIADB Industrial Estate, Hoskote, Bangalore – 562114
Ph: +91 90194 22331 | Fax: +91 80 27971749
sales@toyamaindia.com | www.toyamaindia.com

Wiring Diagram:

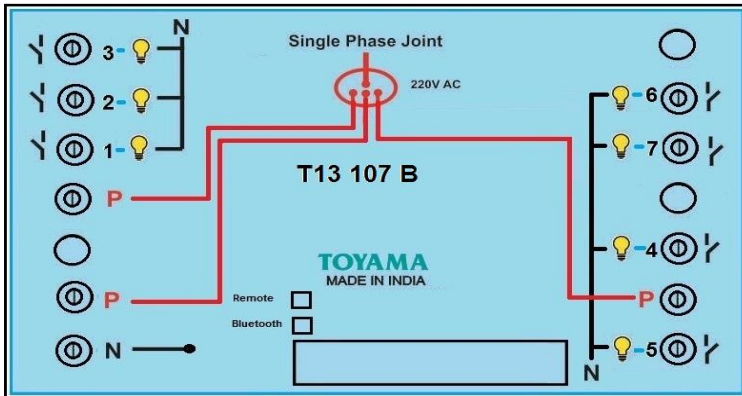

Mounting Bluetooth Switch On To Box:

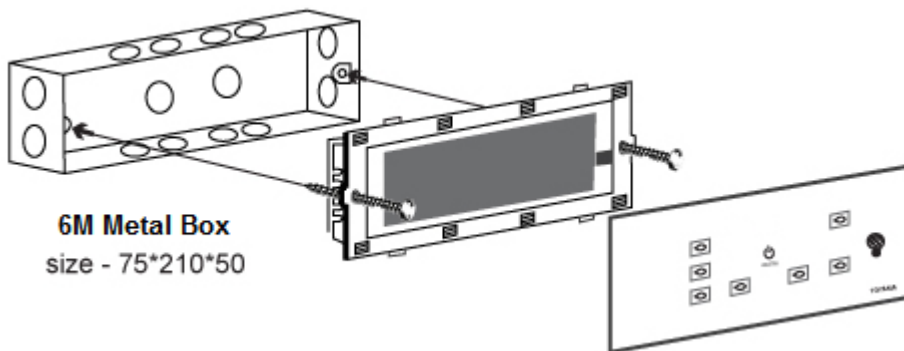

Note: Suitable For

- Mounting on 6 module metal box (75mmX210mmX50mm)
- Use 1.5 Sq.mm flexible wires for Phase, Neutral & Load connections.

Safety Warnings:

- If the input voltage increases to 440V the device will burn.
- Each on/off circuit is rated to 5A **resistive** load only. If the load is greater than the specification the device will be damaged and will no longer functions.
- If it is LED or CFL fittings connect one or two only per circuit. Anything more may weld the switch contacts and leave the loads permanently ON
- If a direct short is created on the output /load, the device will be damaged and will no longer functions.

Standard Warranty:

- Toyama offers a standard 24 months limited warranty on all the Touch Art switches.